

100 mm

120 mm

**PHILIPS**

**hue** personal  
wireless  
lighting

17466/\*\*/P7



HUE serial number

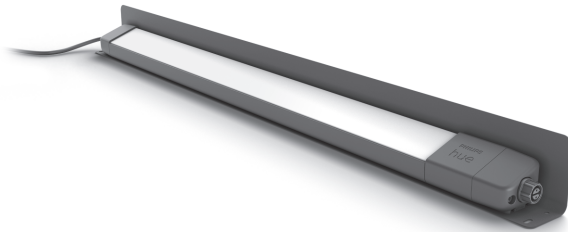

User manual  
Benutzerhandbuch  
Notice d'emploi  
Manual de usuario  
Manual do usuário  
Manuale d'uso

100 mm

120 mm

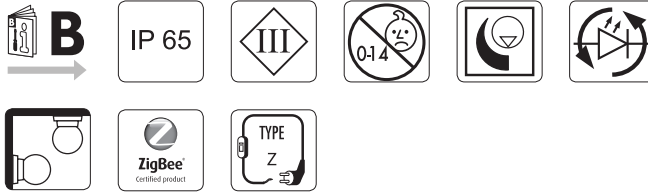
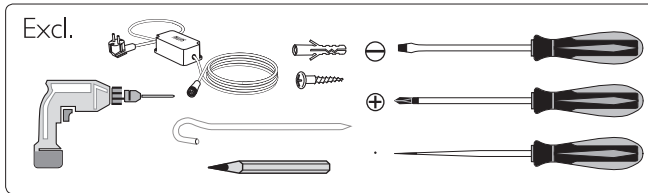
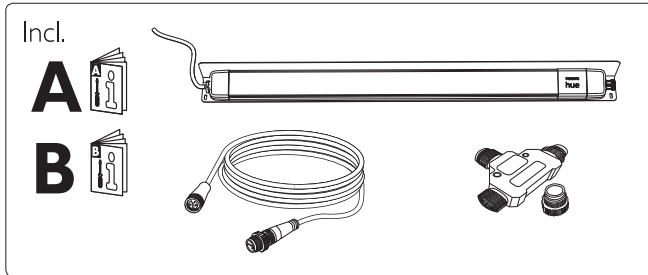

100 mm

120 mm

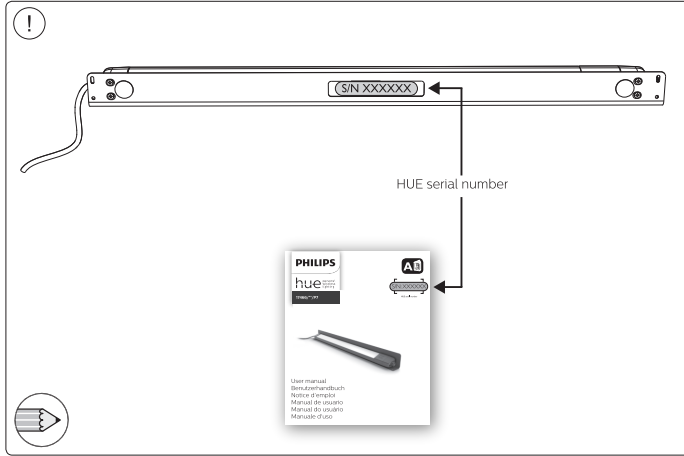

3

100 mm

120 mm

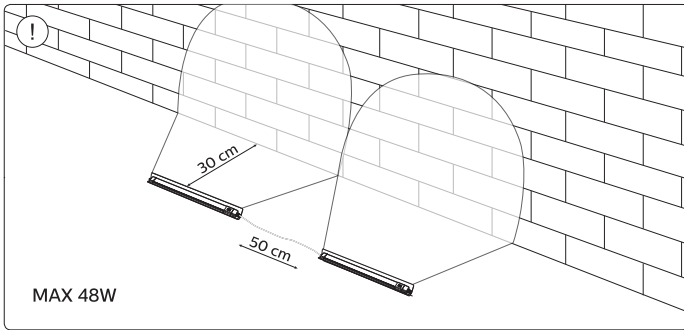
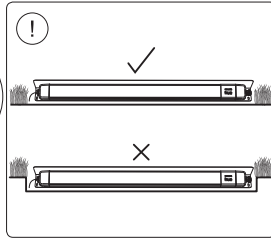
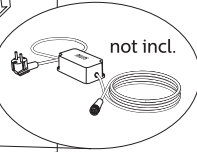
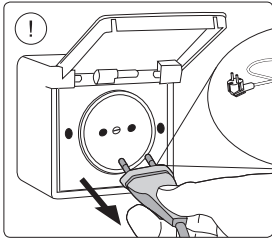

100 mm

120 mm

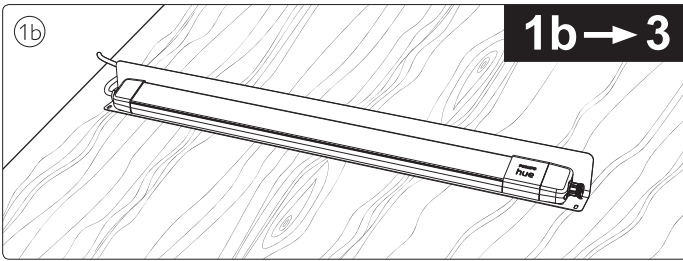
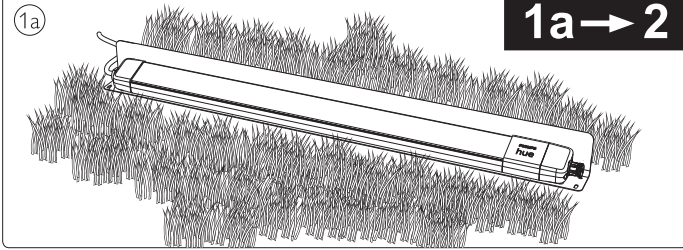

5

100 mm

2 → 6

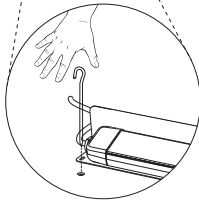
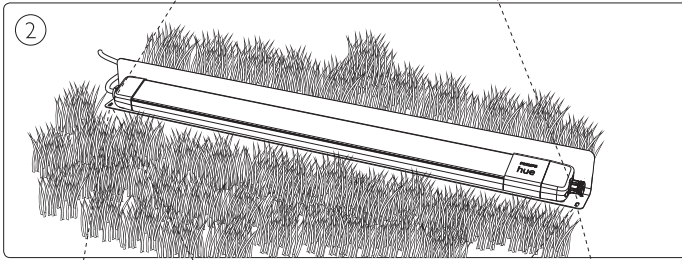
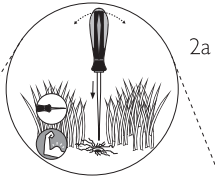

2b

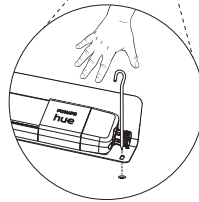

6

120 mm

100 mm

120 mm

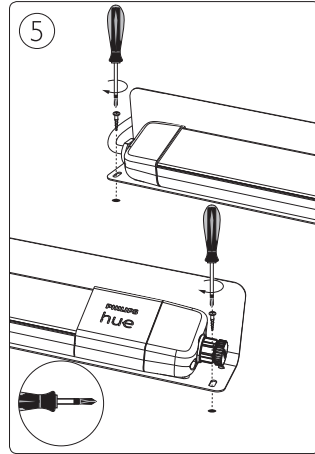
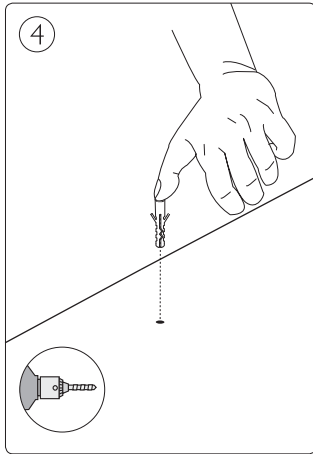
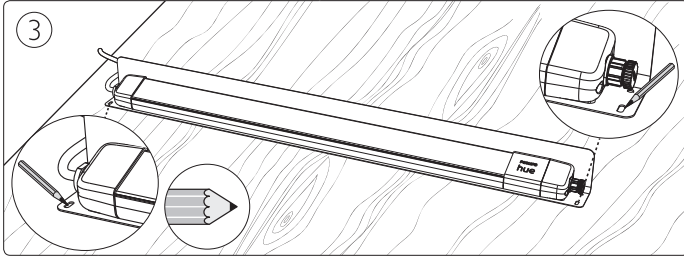

100 mm

120 mm

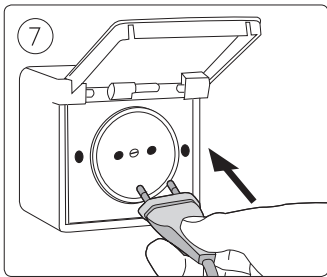
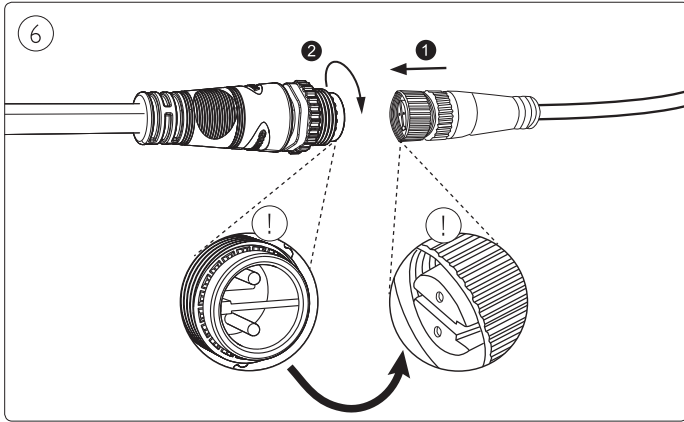

8



100 mm

120 mm

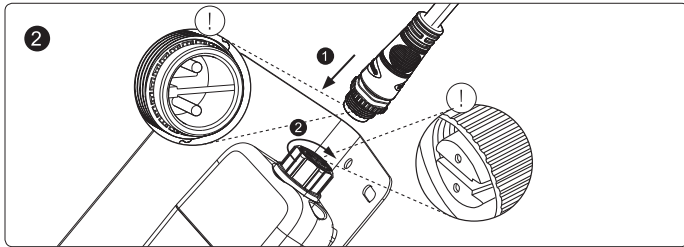
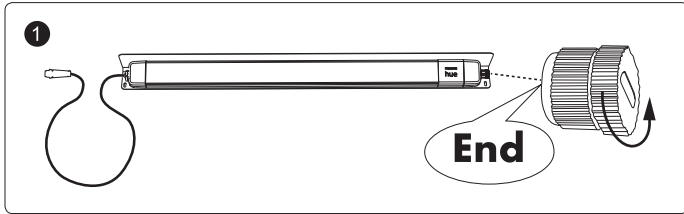
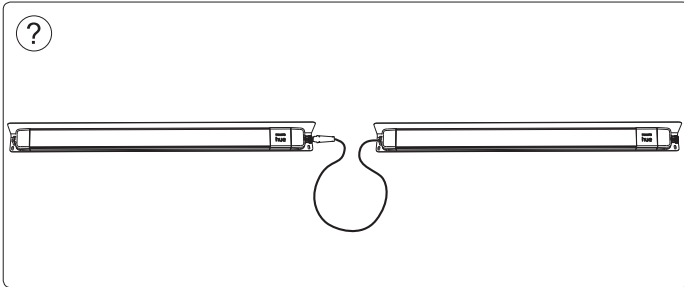

100 mm

120 mm

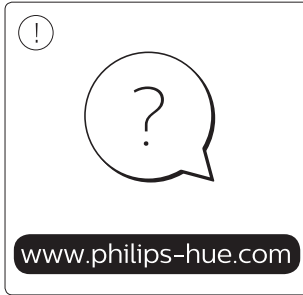

[www.philips-hue.com/getstarted](http://www.philips-hue.com/getstarted)

100 mm

120 mm



- EN** Use only with Philips Hue 24V **SELV** IP67 LED power supply!
- DE** Verwendung nur mit Philips Hue 24V **SELV** IP67 LED-Stromversorgung!
- FR** Utiliser uniquement avec l'alimentation LED Philips Hue 24V **SELV** IP67!
- ES** Se utiliza solo con la fuente de alimentación LED Philips Hue SELV 24V **IP67**!
- PT** Utilize apenas com fonte de alimentação LED SELV Philips Hue de 24V **IP67**!
- IT** Da utilizzare solo con un alimentatore LED Philips Hue 24V **IP67**!

#### Low Voltage system

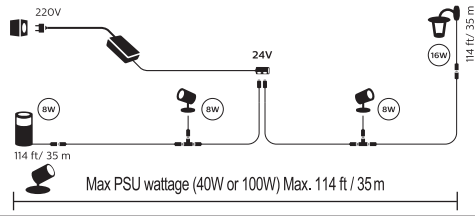

100 mm

120 mm



Signify  
I.B.R.S. / C.C.R.I. Numéro 10461  
5600 VB Eindhoven,  
the Netherlands  
☎00800-74454775

Signify Australia Limited  
65 Epping Road, North Ryde,  
NSW, 2113 Australia  
Toll Free number: 1300 304 404

Signify New Zealand Limited  
123 Carlton Gore Road  
Newmarket, Auckland 1023  
New Zealand  
Tel: 0800 454 448

© 2020 Signify Holding  
All rights reserved.

[www.philips-hue.com](http://www.philips-hue.com)

440402913351\_V02  
Last update: 10/2020